

Installation, Operation, and Maintenance Manual

CEMLINE CORPORATION®

**Electronic Controls for Steam Generators
with RWD62U Controller**

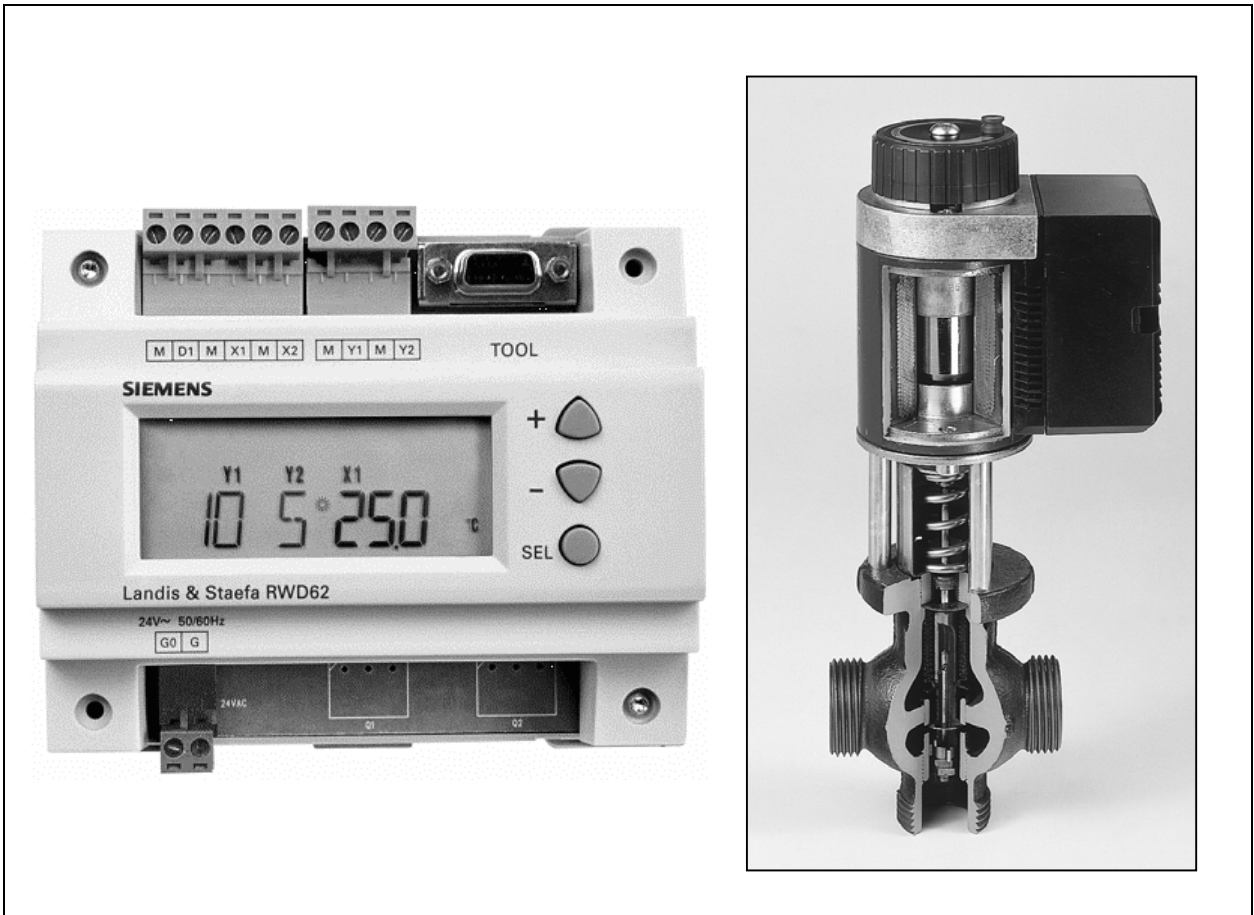

CEMLINE CORPORATION

P. O. BOX 55 CHESWICK, PENNSYLVANIA 15024

Phone: (724) 274-5430 FAX (724) 274-5448

www.cemline.com

Table of Contents

<u>Section</u>	<u>Page</u>
Disclaimers	1
Contact Information	1
General Notes and Warnings	2
Warnings	2
Connecting the Electric Power Source	3
The Controller	4
Adjustments	4
Wiring Diagram for M2H and M3P Valves	6
Wiring Diagram for MXG and MFX Valves.....	7
Wiring Diagram for MXF Valves.....	8
Testing the Pressure Sensor	9
MXG and MXF Valve Information	9
MXG and MXF Valve Calibration	10
M3P and M2H Valve Information.....	11
MVF Valve Information	12
General Valve Information	14
Magnetic Coil Resistance Information	15
Notes	16

© 2006 Cemline Corporation. All Rights Reserved.

All trademarks in this manual are property of Cemline Corporation, unless otherwise noted or in any other way set forth as a third party rights. Unauthorized use of these trademarks, as well as the materials presented in this manual, is expressly prohibited and constitutes a violation of the intellectual property rights of Cemline Corporation.

Disclaimers

This Installation, Operation, and Maintenance Manual is intended to be as complete and up to date as possible. It covers the installation, operation, and maintenance procedures for CEMLINE CORPORATION's Electronic Controls. CEMLINE® reserves the right to update this manual and other product information concerning installation, operation, and/or maintenance, at any time and without obligation to notify product owners of such changes.

CEMLINE is not responsible for inaccuracies in specifications, procedures and/or the content of other product literature, supplied by the manufacturers of components used in CEMLINE Electronic Controls. CEMLINE strives to use only the highest quality components; however, CEMLINE has no direct control over their manufacture, or their consistent quality.

CEMLINE is not responsible for injury to personnel or product damage due to the improper installation, operation, and/or maintenance of CEMLINE Electronic Controls. All installation, operation, and maintenance procedures should only be performed by trained/certified personnel. All personnel performing these procedures should completely and carefully read and understand all supplied materials before attempting the procedures. All personnel should pay strict attention to all Notes, Cautions, and Warnings that appear within the procedures detailed in this manual.

CEMLINE welcomes user input as to suggestions for product or manual improvement.

Contact Information

For information concerning warranties, or for questions pertaining to the installation, operation or maintenance of CEMLINE products, contact:

CEMLINE CORPORATION
P.O. Box 55
Cheswick, PA 15024

USA Phone: (724) 274-5430
USA Fax: (724) 274-5448
www.cemline.com

To order replacement parts, contact CEMLINE CORPORATION at the address listed above, or call toll free:

USA/Canada/Caribbean Phone: (800) 245-6268

Note: Please include the model and serial number of the unit for which the parts are being ordered. If ordering by phone, please have this information readily available.

General Information

Notes

- ❖ This manual is intended to cover installation, operation, and maintenance procedures for CEMLINE CORPORATION Electronic Controls.

If questions are not answered by this manual, or if specific installation, operation, and/or maintenance procedures are not clearly understood, contact CEMLINE CORPORATION for clarification before proceeding.
- ❖ All installation, operation, and maintenance procedures should be performed only by - experienced, trained and certified personnel. Personnel should be trained in and familiar with correct piping and electrical procedures and methods, and should be experienced in working with hot/boiler water systems.
- ❖ CEMLINE CORPORATION Electronic Controls are designed for indoor use only, unless otherwise required by design specifications.
- ❖ If the unit is damaged during installation, operation, or maintenance, complete the following steps:
 1. Turn off and lock out the electric power supply to the unit in an approved manner.
 2. Turn off all incoming steam valves.
 3. Contact in-house maintenance personnel or CEMLINE CORPORATION for instructions.

Warnings

As with any piece of equipment that utilizes hot/boiler water and electricity, **the potential exists for severe personal injury** if proper installation, operation, and maintenance procedures are not followed. Listed on the following pages are specific warnings pertaining to CEMLINE Electronic Controls. **All warnings should be carefully read and understood.** All precautions contained in the warnings should be carefully followed to reduce the chance of injury.

Note: Throughout this manual, warnings will be denoted by the symbol ▼ .

All documentation for each major component has been included with the unit. It is strongly recommended that each document be reviewed before attempting any installation, operation, or maintenance procedures.

The documentation for each major component may also contain warnings and cautions identified by the manufacturer of each component. These warnings and cautions may be specific for the particular component, and therefore not covered in this general Installation, Operation, and Maintenance Manual. They should also be carefully reviewed before attempting installation, operation, or maintenance procedures.

- ▼ The combination of electricity and water can pose a **very dangerous situation**. Assure that all power has been **shut off/disconnected and locked out** in an appropriate manner, before attempting any installation or maintenance procedures.
- ▼ Areas of potential danger:
 1. all electric power leads and connections;
 2. all hot/boiler water lines, steam lines, joints, valves, and relief valves; and
 3. all joints at valve, gauges, etc.
- ▼ Before attempting any installation, operation, or maintenance procedures pertaining to the unit.
 1. assure that the electric power supply has been turned off and locked out in an approved manner;
 2. if the unit has been in operation, allow the water in the tank, as well as all components and surfaces (heating elements, hot water outlet lines, etc.) to cool before starting the procedure;
 3. assure that all incoming and outgoing water and steam lines have been turned off at the manual shutoff valves; and
 4. completely drain the tank, after allowing the water time to cool.
- ▼ Hot/boiler water and steam present a situation that can be very dangerous due to the fact it is under pressure and at very high temperatures. To avoid possible injury or death, use common sense and follow all accepted and recommended procedures when - performing installation, operation, and maintenance procedures.

Connecting the Electric Power Source

- ▼ All installation procedures involving electric power connection should only be performed by trained, certified electricians.
- ▼ Hot/boiler water and steam present a situation that can be very dangerous because of the high temperatures and pressures. Use common sense and follow all accepted and recommended procedures when performing installation, operation, and maintenance - procedures to avoid possible injury or death.
- ▼ The combination of electricity and water can pose a very dangerous situation. Assure that all power has been shut off/disconnected and locked out in an approved manner, before attempting any installation or maintenance procedures.

The CEMLINE Steam Generators have been wired during assembly. Connecting the electric power supply to the unit consists of connecting the correct voltage, phase, and amperage power leads to the terminal strip or circuit breaker. The exact voltage, phase, and amperage requirements for the unit can be determined from the rating plate affixed to the jacket of the unit, or from the Submittal Sheet and Wiring Diagrams supplied with the unit.

The Controller

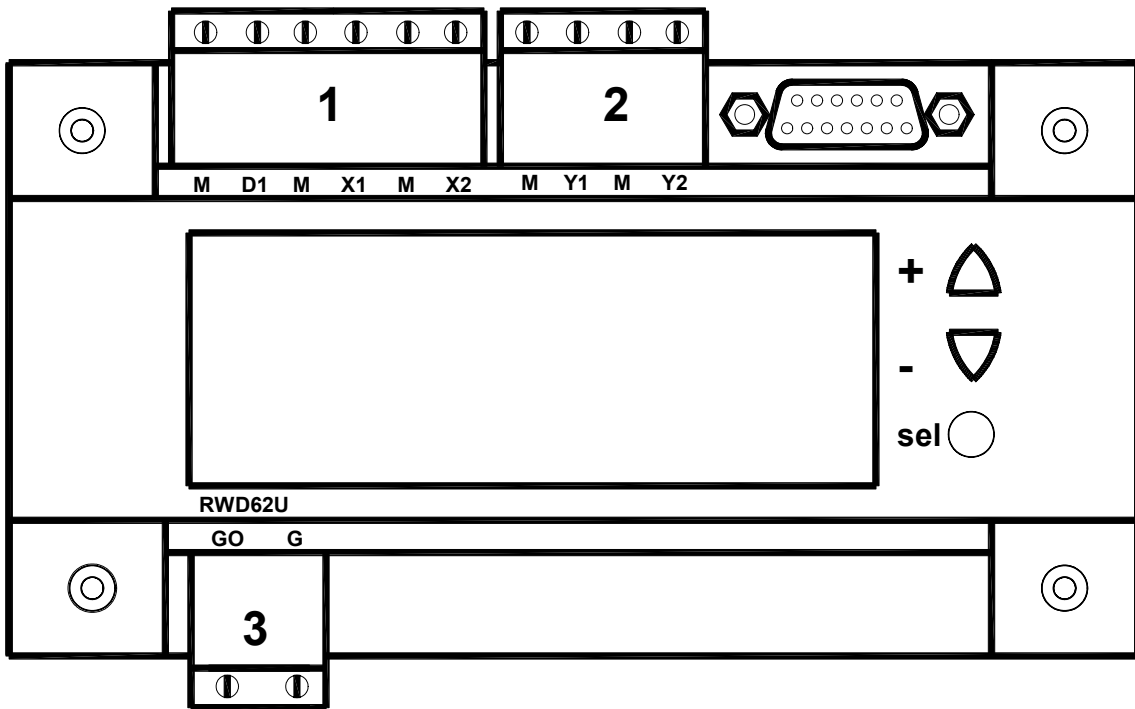

Terminal Layout

G-GO: AC 24 V supply
M: Ground (GO) for signals, universal inputs, analog outputs
X: Pressure Sensor input.
Y: Analog output

Connectors

1. Pressure Sensor Connection
2. 0-10 V DC Output Connector
3. 24 V AC Power Supply Connector

Adjustments

X1 – operating pressure (psig)

- ▼ ▲ ^{+, -} info buttons
These buttons scroll through the functions codes in a predetermined order. Once the required variable is flashing, these buttons are used to increase/decrease the value.
- select button
Chooses the desired function to be edited and also accepts the user selected values.

Main Screen

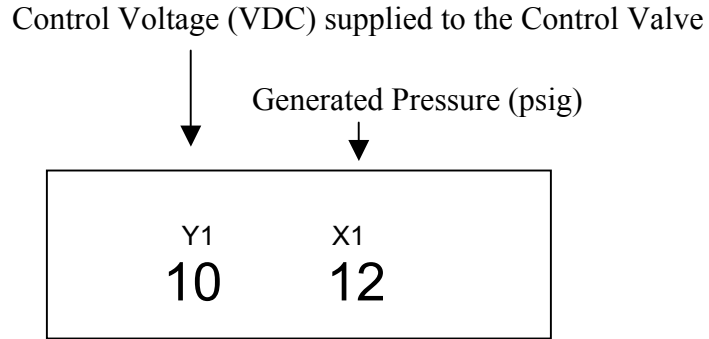

The main screen on the RWD62U controller shows information related to the operating conditions of the steam generator. In the lower left hand corner is a display value between 0 and 10 that represents the number of volts DC being sent to the control valve. At 0 volts the valve will be closed and at 10 volts the valve will be fully open. In the lower right hand corner is the display pressure of the steam generator in psig.

Operating Pressure Set Point (psig)

This is the operating pressure set point of the steam generator. The high limit set point is set on the SSCM-2001 control module. See the SSCM-2001 control module for setting the high limit set point.

Adjusting the Operating Pressure Set Point

1. From the main screen push the + button one (1) time until SP-1 appears in the left hand corner of the LCD display. (See the screen image below).



2. Push the select button. This will cause the set point number to blink.
3. Push + or - to select the desired operating temperature set point.
4. Push the select button to lock in the set point. When the set point is locked in the number will stop blinking.
5. Push the - button one (1) time to go back into the main menu screen or the controller will automatically go back to the main screen after 20 seconds.

▼ **CAUTION: DO NOT set the operating pressure on the RWD62U higher than the high limit set point on the SSCM-2001. This will cause improper operation of the unit, with the potential for DANGER while causing alarms to go off.**

Wiring Diagram – M2H and M3P Valves

Wiring Diagram of Electronic Control Valve for Steam Generators using a RWD62U Controller

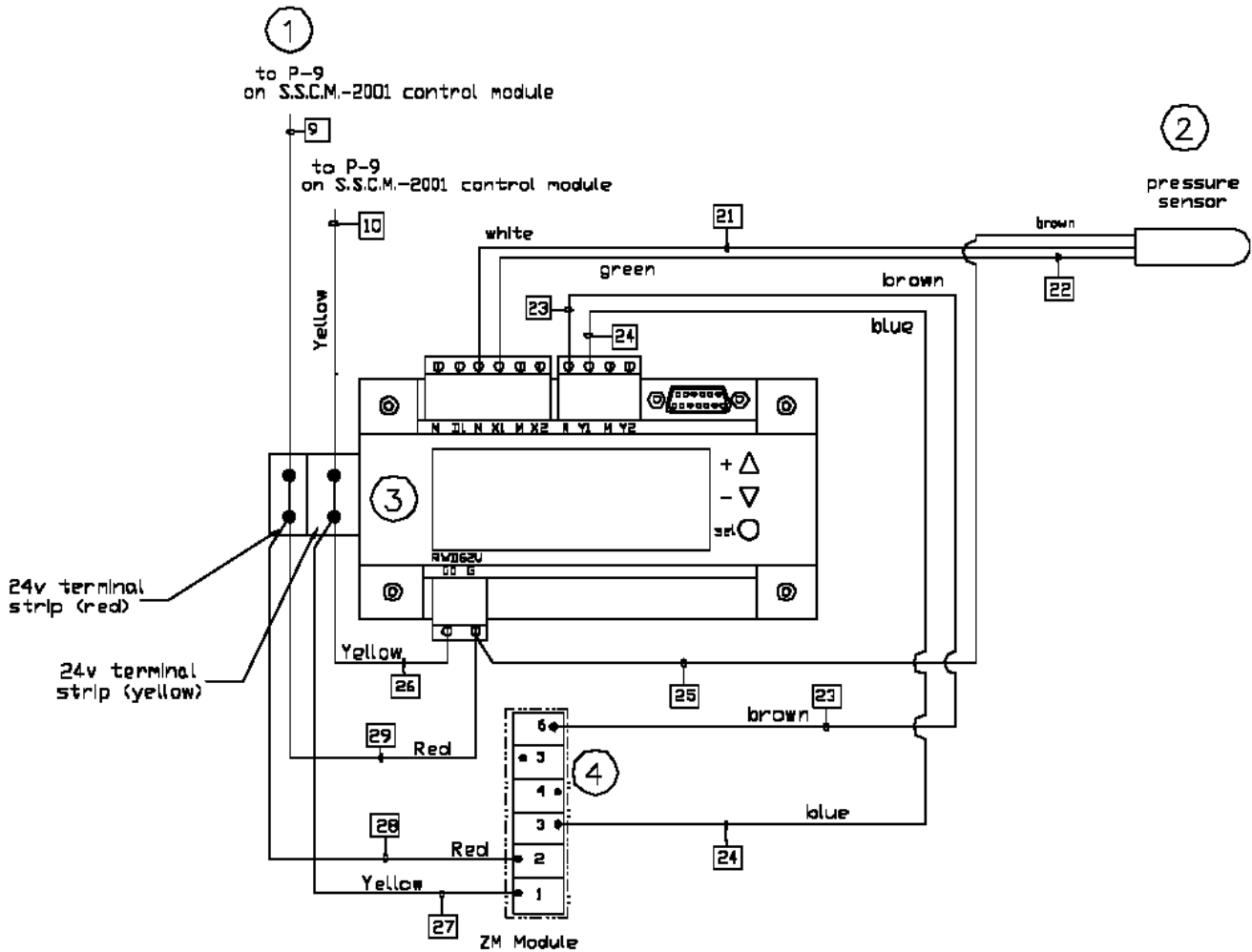

Loss of power will close control valve

Disconnect switch provided by others

○ Indicates part number

□ Indicates wire number

#	DESCRIPTION
1	SSCM-2001 Control Module
2	Operating Pressure Sensor
3	Controller
4	Valve Module



Wiring Diagram – MXG and MXF Valves

Wiring Diagram of Electronic Control Valve for Steam Generators using a RWD62U Controller

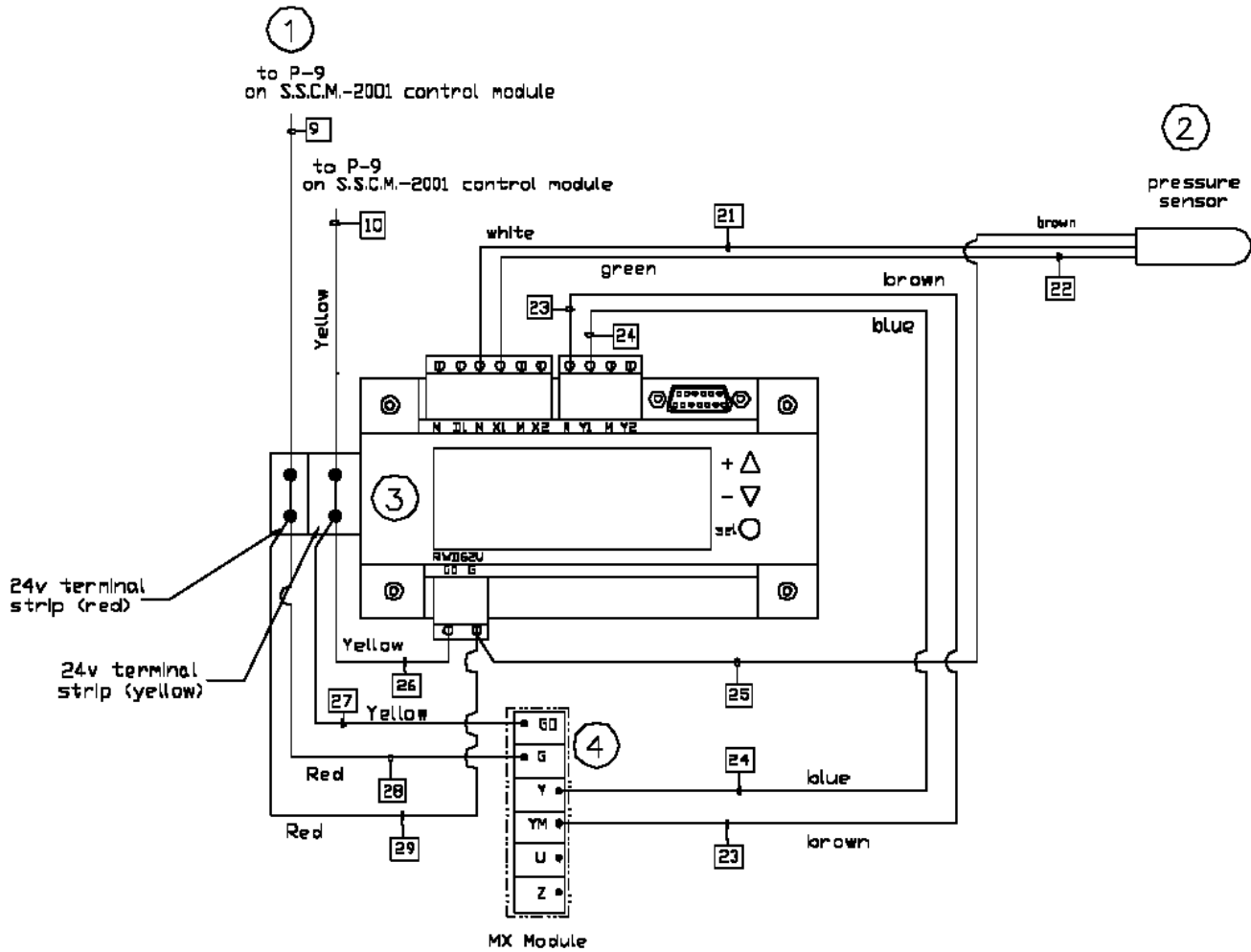

Loss of power will close control valve

Disconnect switch provided by others

○ Indicates part number

□ Indicates wire number

#	DESCRIPTION
1	SSCM-2001 Control Module
2	Operating Pressure Sensor
3	Controller
4	Valve Module



Wiring Diagram – MVF Valves

Wiring Diagram of Electronic Control Valve for Steam Generators using a RWD62U Controller

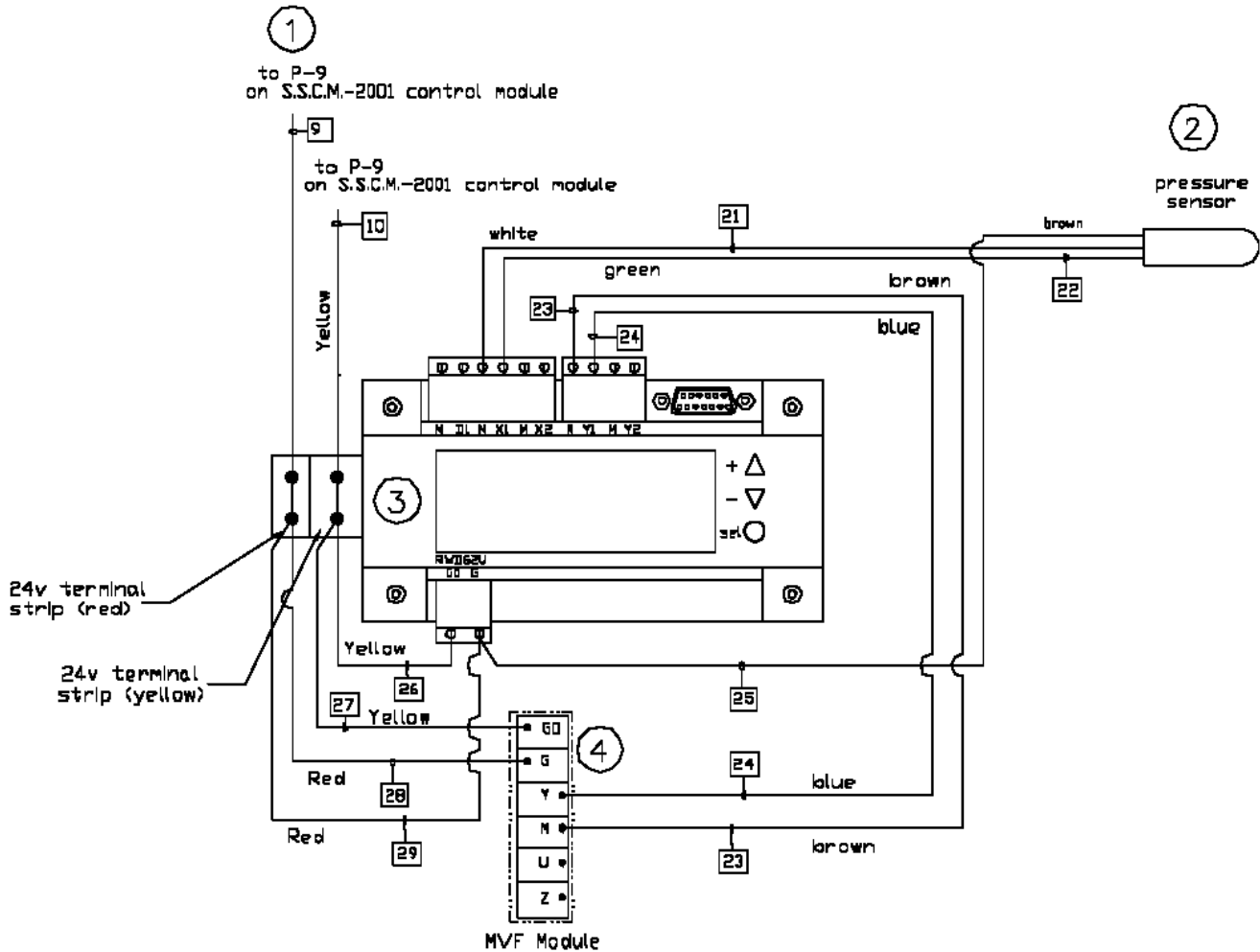

Loss of power will close control valve

Disconnect switch provided by others

○ Indicates part number

□ Indicates wire number

#	DESCRIPTION
1	SSCM-2001 Control Module
2	Operating Pressure Sensor
3	Controller
4	Valve Module



Testing the Pressure Sensor

The pressure sensor includes an integrated diaphragm, position sensor and electronic transmitter. When connected to the controller, you can measure a voltage directly proportional to the sensed pressure.

Check the voltage by holding the volt meter probes on the controller terminals B1(+) and M(-).

The output voltage is a linear function (0-10 volts dc) of the pressure range indicated on the pressure sensor.

MXG and MXF Valve Information

The MXG and MXF valves can be configured for linear and equal percentage operation. Factory settings is equal percentage.

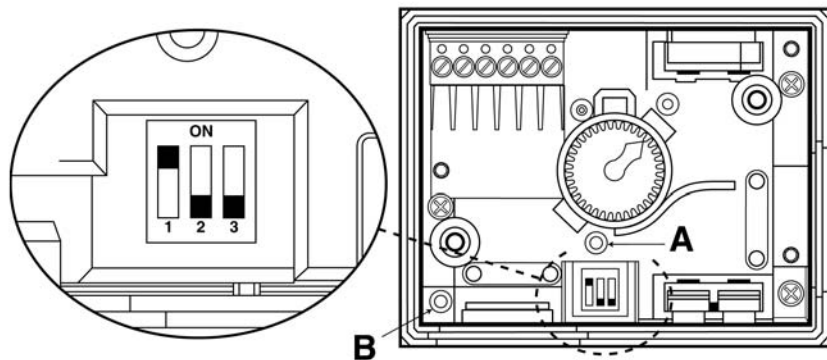

Switch	OFF	ON
1	Characteristic Linear	Equal percentage *
2	Control signal — must be in the OFF position	
3	Volts or mA — must be in the OFF position	

Valve Calibration

The MXG and MXF valves are factory-calibrated at 0% and 100% stroke. When commissioning the valves, however, (especially under extreme conditions of use) there may still be some leakage via control path A → AB (below, and marked on the valve). In this case, the valve can be recalibrated simply and quickly as follows. Remove the screws from the top of the electrical housing on the control valve and remove the cover. Using a pointed implement (2mm diameter) to operate the button in the opening [A] in the terminal housing. While recalibration is in progress, the LED [B] in the electronics module will flash green for approximately 10 seconds. The valve will be briefly closed and fully opened.

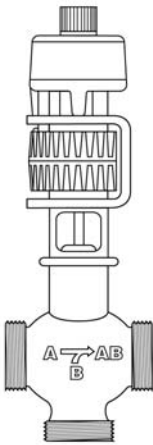

The two-color LED display [B] indicating operating status can be viewed by opening the cover the the electronics module.

LED green	On continuously	Automatic mode: 'Auto' (normal, no faults)
	Flashing	<ul style="list-style-type: none"> – Mechanically set to 'Manual' – Mechanically set to 'Off' – Currently in 'Calibration' mode
LED red	On continuously	<ul style="list-style-type: none"> – General fault – General calibration error – Microcontroller fault
	Flashing	– Faulty AC 24 V supply (e.g. too low)
LED	Off	<ul style="list-style-type: none"> – No AC 24 V supply – Faulty electronics module

As a general rule, the LED can assume only the states shown above (continuously red or green, flashing red or green, or off).

Warning

The control valve has a hand wheel knob on the top of the valve (see diagram below). This control knob must be placed into the automatic position (AUTO). The AUTO position allows automatic control of the valve to occur. By placing the hand wheel in the OFF position the valve will not close. **Do not place the wheel in the manual position.** By placing the wheel in the manual position prevents the control program to function correctly and is dangerous to the operation of the unit. **The hand wheel knob must be in the auto position.**

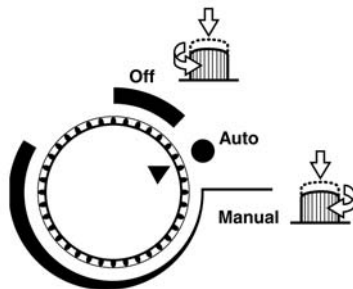

M3P and M2H Valve Information

Valve Calibration

The M3P and M2H valves are factory-calibrated at 0% and 100% stroke. When commissioning the valves, however, (especially under extreme conditions of use) there may still be some leakage via control path 1 → 2 for the M2H and 1 → 3 for the M3P (*see below*, and marked on the valve) with a 0% stroke control signal (DC 0V, DC 4 mA or DC 2 V). In this case, the valve can be recalibrated simply and quickly as follows. Remove the left screw of the electronic module also known as the ZM module. Use a pointed implement (2mm diameter) or a screwdriver No. 0 or 1 to push in the switch in the electronics module (*see below*). While recalibration is in progress, the LED in the electronics module will flash green for approximately 10 seconds. The valve will be briefly closed and fully opened, full stroke is maintained for 1 to 3 seconds and the valve closes again. The valve will then go to the position which corresponds to the position signal. If the LED continues to flash after 10 seconds there was an error in operation during the calibration process or there is another fault.

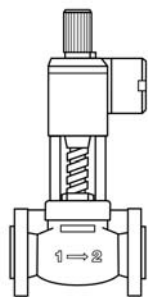

M2H

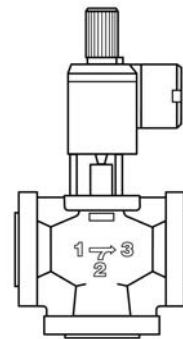

M3P

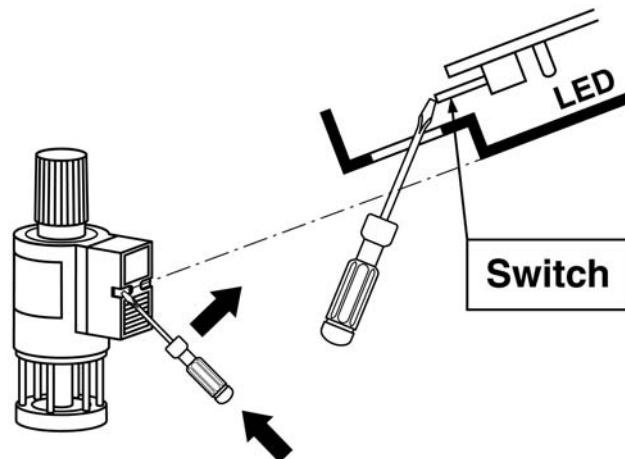

MVF Valve Information

The MVF valve can be configured for linear and equal percentage operation. Factory setting is equal percentage.

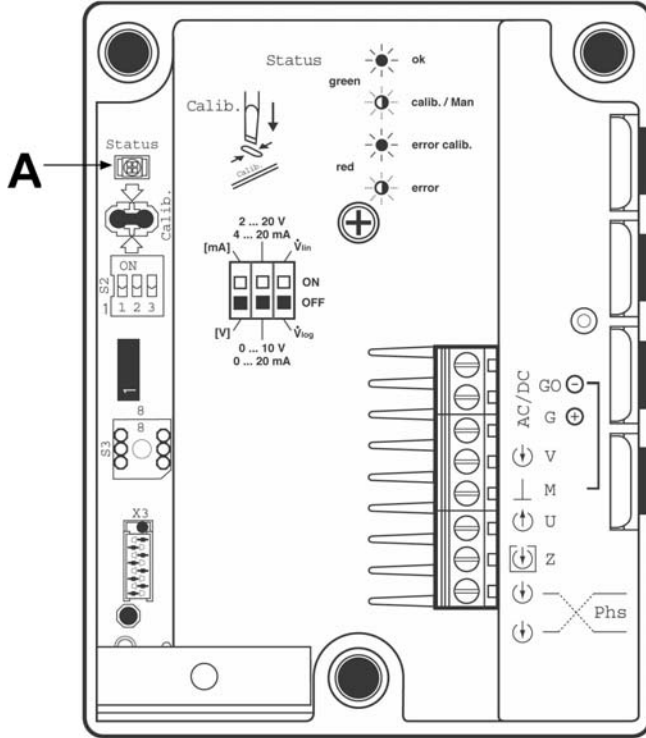

Switch	OFF	ON
1	Volts or mA — must be in the OFF position	
2	Correcting span — must be in the OFF position	
3	Characteristic Equal percentage *	Linear

Valve Calibration

The MVF valves are factory-calibrated at 0% and 100% stroke. When commissioning the valves, however, (especially under extreme conditions of use) there may still be some leakage via control path A → AB and the valve's electronics must be recalibrated. To recalibrate, the hand wheel must be set into the automatic position (AUTO).

Remove the screws from the top of the electrical housing on the control valve and remove the cover. The printed circuit board has a slot for calibration (see diagram below). Calibrate by bridging the contacts located behind the slot on the printed circuit board, using a screwdriver. The valve will then travel across the full stroke to store the end positions. While recalibration is in progress, the LED [A] in the electronics module will flash green for approximately 10 seconds. The valve will be briefly closed and fully opened. The valve will then go to the position which corresponds to the position signal. If the LED continues to flash after 10 seconds there was an error in operation during the calibration process or there is another fault.

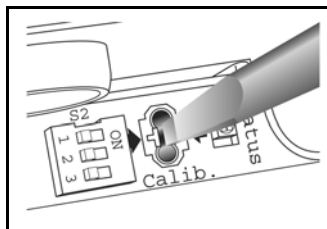

The two-color LED display [A] indicating operating status can be viewed by opening the cover the the electronics module.

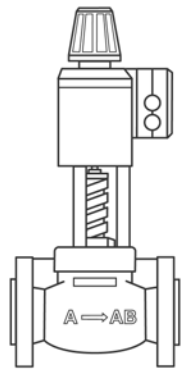
 <p style="text-align: center;">MVF</p>		Indication	Operating State, Function	Remarks, Troubleshooting
	Green	Lit	Control mode	Normal operation; everything OK.
		Flashing	Calibration In manual control	Wait until calibration is finished (green or red LED will be lit) Hand wheel in Man or Off position
	Red	Lit	Calibration error Internal error	Recalibrate (bridge contacts behind the calibration slot) Replace electronics module
		Flashing	Main fault DC Supply - / +	Check electric main network (outside the frequency or voltage range); VDC supply +/- connection polarity
	Both	Dark	No power supply Electronics faulty	Check electric main network, check wiring Replace electronics module

Warning

The control valve has a hand wheel knob on the top of the valve (see diagram below). This control knob must be placed into the automatic position (AUTO). The AUTO position allows automatic control of the valve to occur. By placing the hand wheel in the OFF position the valve will not close. **Do not place the wheel in the manual position.** By placing the wheel in the manual position prevents the control program to function correctly and is dangerous to the operation of the unit. **The hand wheel knob must be in the auto position.**

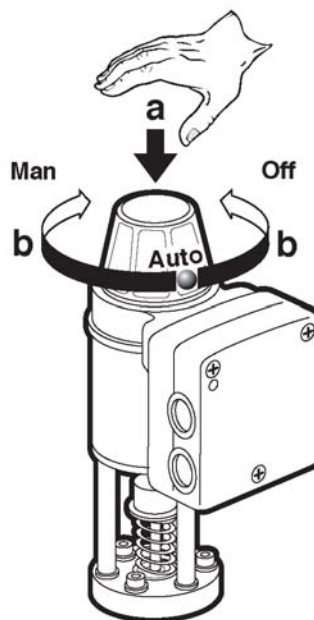

General Valve Information

The valve is factory assembled and does not require repacking or other periodic service.

Testing

1. Remove power from the controller by removing the orange connector at pins GO, G, G which is connector (3) on page 4.
2. Remove the control module from the valve by loosening the two mounting screws.
3. Measure the resistance between the two terminals indicated on the drawing on page 12. Also see chart on page 12 for resistance for valve coil. Look on valve for the model number that corresponds with the chart.
4. Check one of above terminals to ground. The resistance should be infinite.
5. Measure the voltage at 24 volt transformer between wires 2 and 9 on the wiring diagrams from pages 6 and 7.
6. Reconnect the control module.
7. Reconnect the power to the controller.

Magnetic Coil Resistance Information

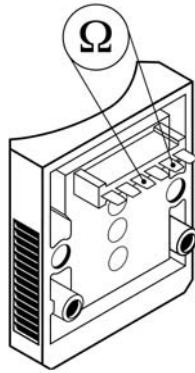

1) Magnetic Coil Resistance (Kl. 7+8)

Valve Model	Actuator Coil
	Resistance (Ω)
M2H15F	21
M2H20FY	21
M2H25FY	21
M2H32FY	15.3
M2H40FY	10
M2H50FY	10
M3P80FY	5.187
M3P100FY	3.34

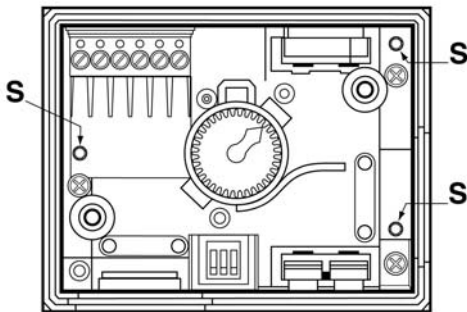

Diagram A

1. Remove the screws from the top of the electrical housing on the control valve and remove the cover.
2. Using a 3 mm Allen wrench remove the 3 Allen head screws (S) which hold the electronic module to the control valve housing (see diagram A).
3. Measure the magnetic coil resistance across the two exposed terminals (see diagram B) and compare the resistance to the chart below.
4. Carefully re-install the electronic control module and cover.

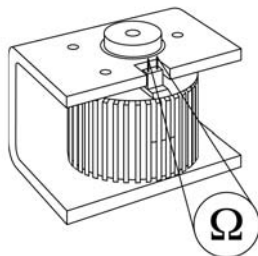

Diagram B

Valve Model	Actuator Coil
	Resistance (Ω)
MXF461.15	9.2
MXF461.65	4.87
MXG461.25	9.2
MXG461.32	9.2
MXG461.40	5.55
MXG461.50	5.55
MXG461.15	9.2

Magnetic Coil Resistance
(Stem stroke length cannot be measured)

Notes

Notes

CEMLINE CORPORATION

P. O. BOX 55 CHESWICK, PENNSYLVANIA 15024
Phone: (724) 274-5430 FAX (724) 274-5448

www.cemline.com
